

boxis

MODEL# R510

500 SHEET AUTO-FEED, MICROCUT SHREDDER-QUICK GUIDE

ATTENTION!



MAINTENANCE: After 250 shredding cycles, "Reset" will be displayed on the LCD panel. Use shredder lubricant sheets that are designed specifically for shredders. **NEVER USE AN AEROSOL LUBRICANT, or COMPRESSED AIR** to clean the shredder. Press and hold the "Reset" button for 3-7 seconds until the "Reset" icon is deactivated.

TROUBLESHOOTING & SUPPORT: Repairs must be performed by the manufacturer's authorized technician. For trouble shooting issues, or questions please call us at **877-972-9387**.

1 Open loading doors

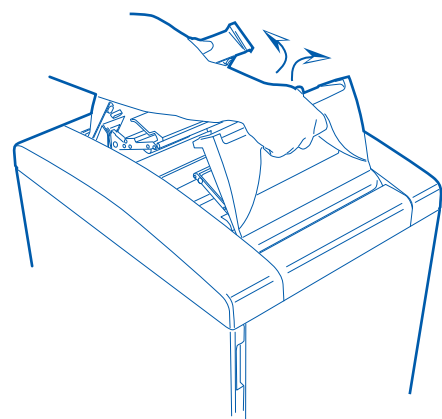

Grip top handles firmly and pull up to open top loading doors.

2 Insert paper: 8 1/2" x 11" or 8 1/2" x 14"

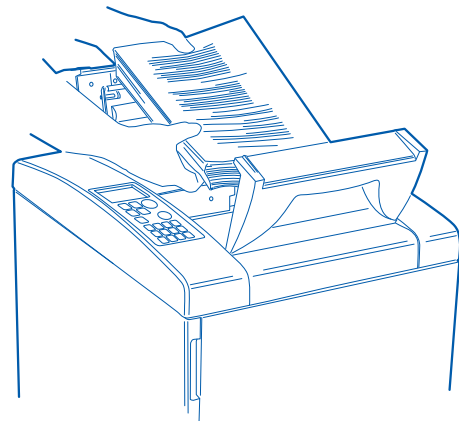

Insert a maximum of 500 sheets of letter size paper or 250 sheets of legal size paper. Always center the paper in the shredder tray.
WARNING: Place 20 lbs. or lighter weight paper.

3 Close loading doors and press start

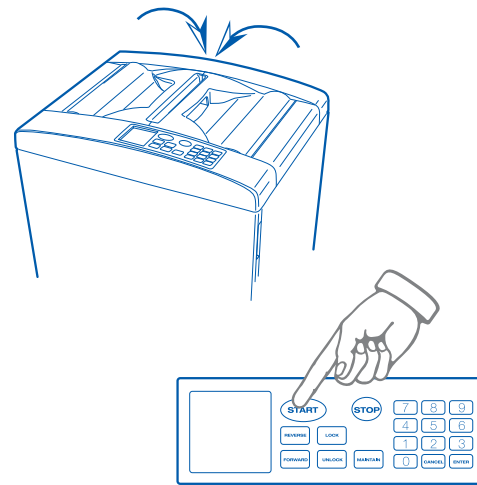

Close loading doors and press the start button.

4 How to lock loading doors using a PIN

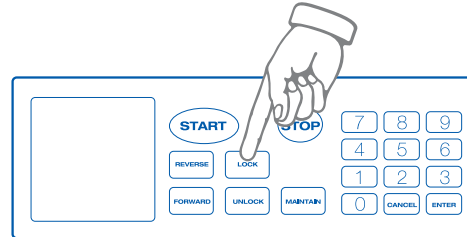

Press "Lock" button. "Enter Password" will flash on display. Enter 4-digit password. (Be sure to remember the password.) Press "Enter" then "Start" to begin shred cycle. Display will read "Cover Lock." Both doors will be locked during shred cycle. Please refer to manual for more detailed explanation.

5 How to unlock loading doors

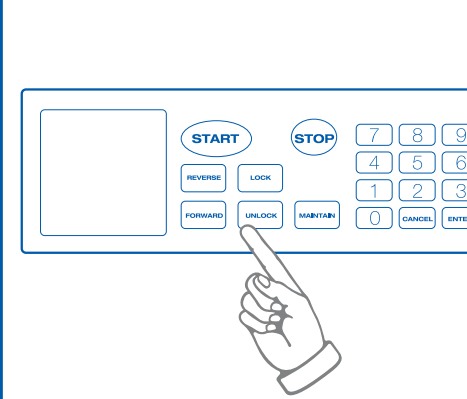

Press "Unlock." Enter your 4 digit PIN. Press "Enter". Display will change to "Cover Unlock". Doors may now be opened.

6 If password is lost, use manual unlocking key

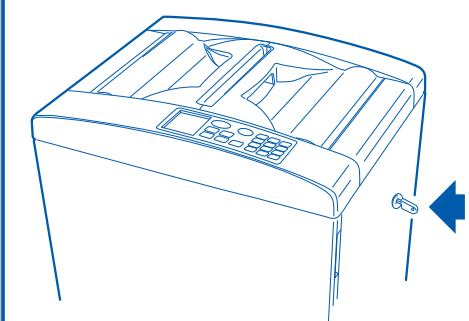

If password is lost or forgotten, there is a manual override switch that is located on the side of the shredder. Contact your administrator to obtain the key. Turn the key to Unlock, then Lock to reset the password.

7 Manual shredding

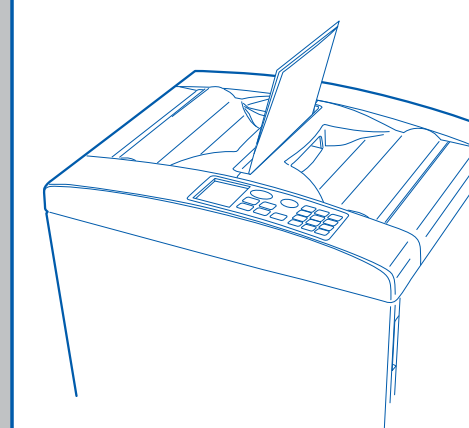

For manual shredding, do not put more than 6 sheets of 20 lb. paper at a time. This may jam or damage the blades.

8 How to empty waste bin

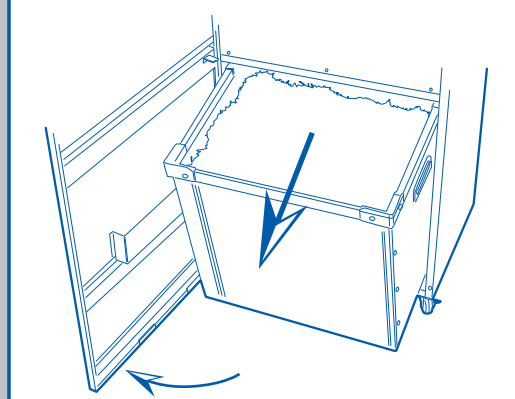

Open cabinet door, remove waste bin and empty shredded waste. Then replace shredder bag and replace the waste bin to shredder.

For More Info 
Click Here --->